

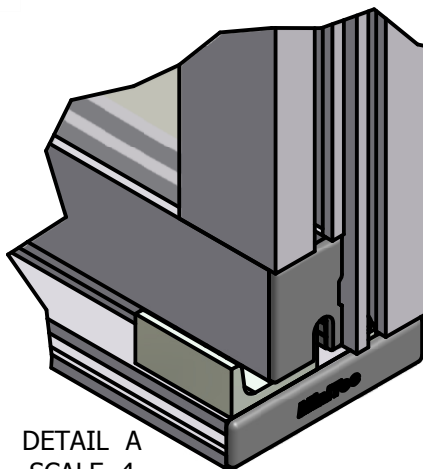

CLEAR POLYCARBONATE (LEXAN®)
FOR DOOR & FIXED PANEL

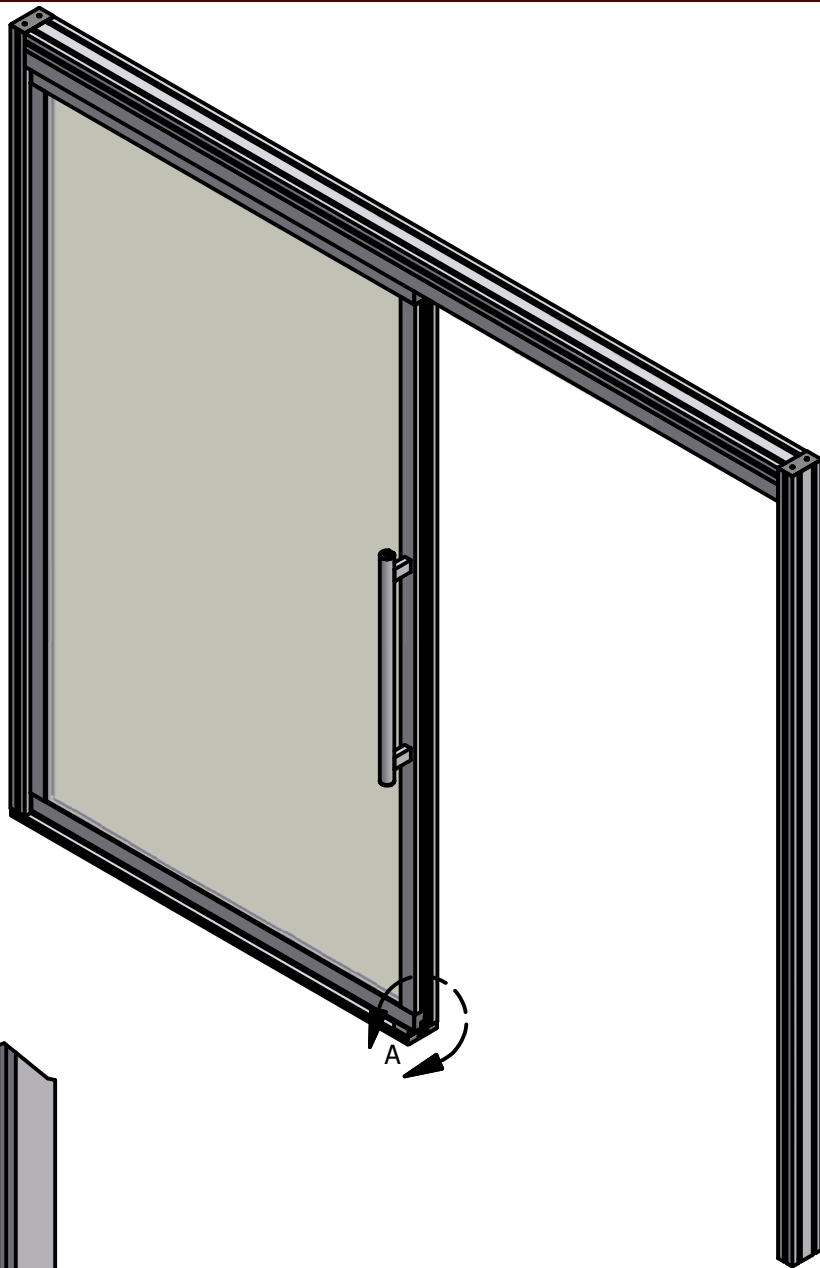
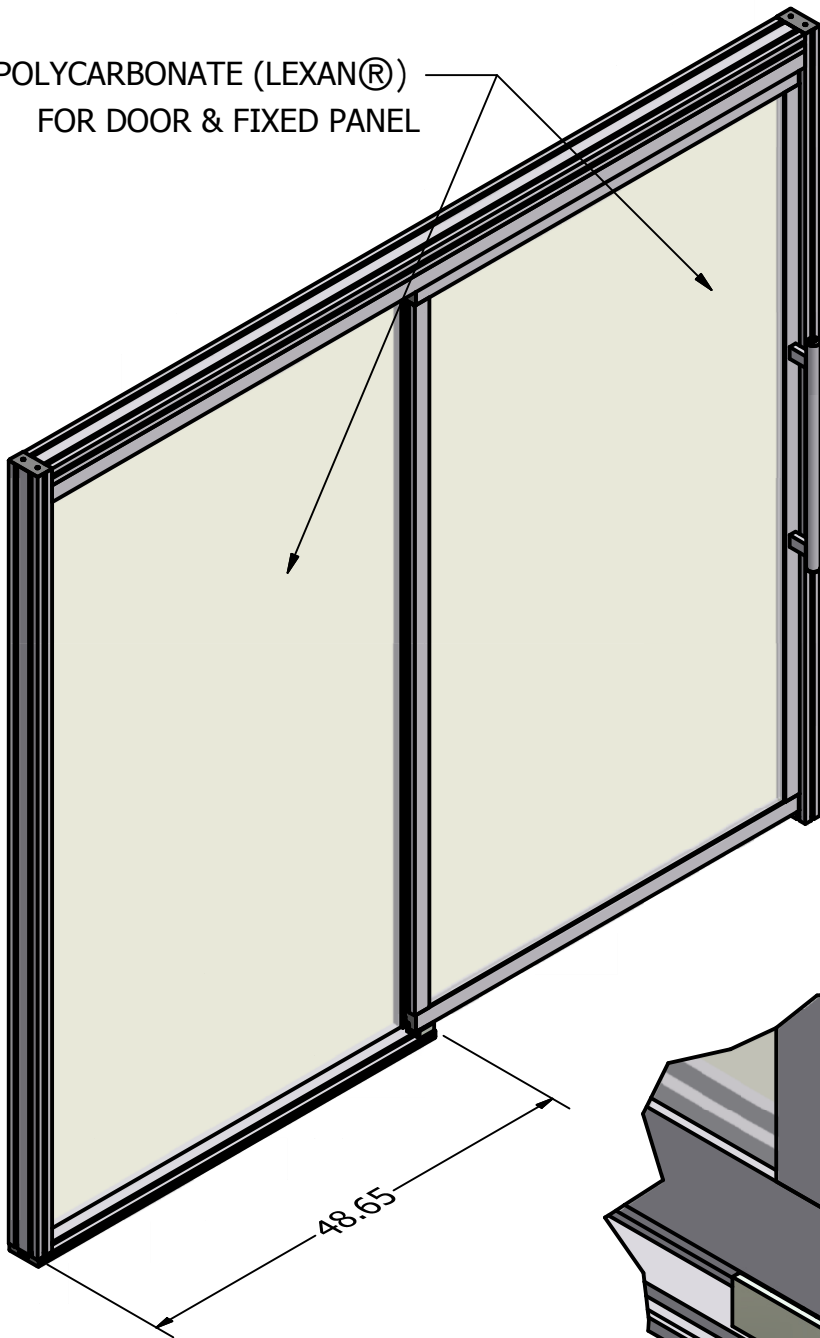

DETAIL A
SCALE .4

PROJECT SP092112-1		 <small>WWW.MINITECFRAMING.COM VICTOR, NY PH # 585 924-4690 DIRECT 585 398-1240 EXT 104 FX # 585 924-4821 amoles@minitecframing.com</small>	<small>UNLESS OTHERWISE NOTED X +/- .12" XX +/- .015" XXX +/- .010"</small>	
DRAWN BY ANDY MOLES			MATERIAL	
DATE 12/10/2012			FINISH	
DRAWN FOR MINITEC'S CUSTOMER		TITLE ADD TITLE		DWG NO SP092112-1
				REV
				SHEET 1 OF 6

SPECIFY SP092112-1 ALONG
WITH WIDTH & HEIGHT
TO GET A QUOTE

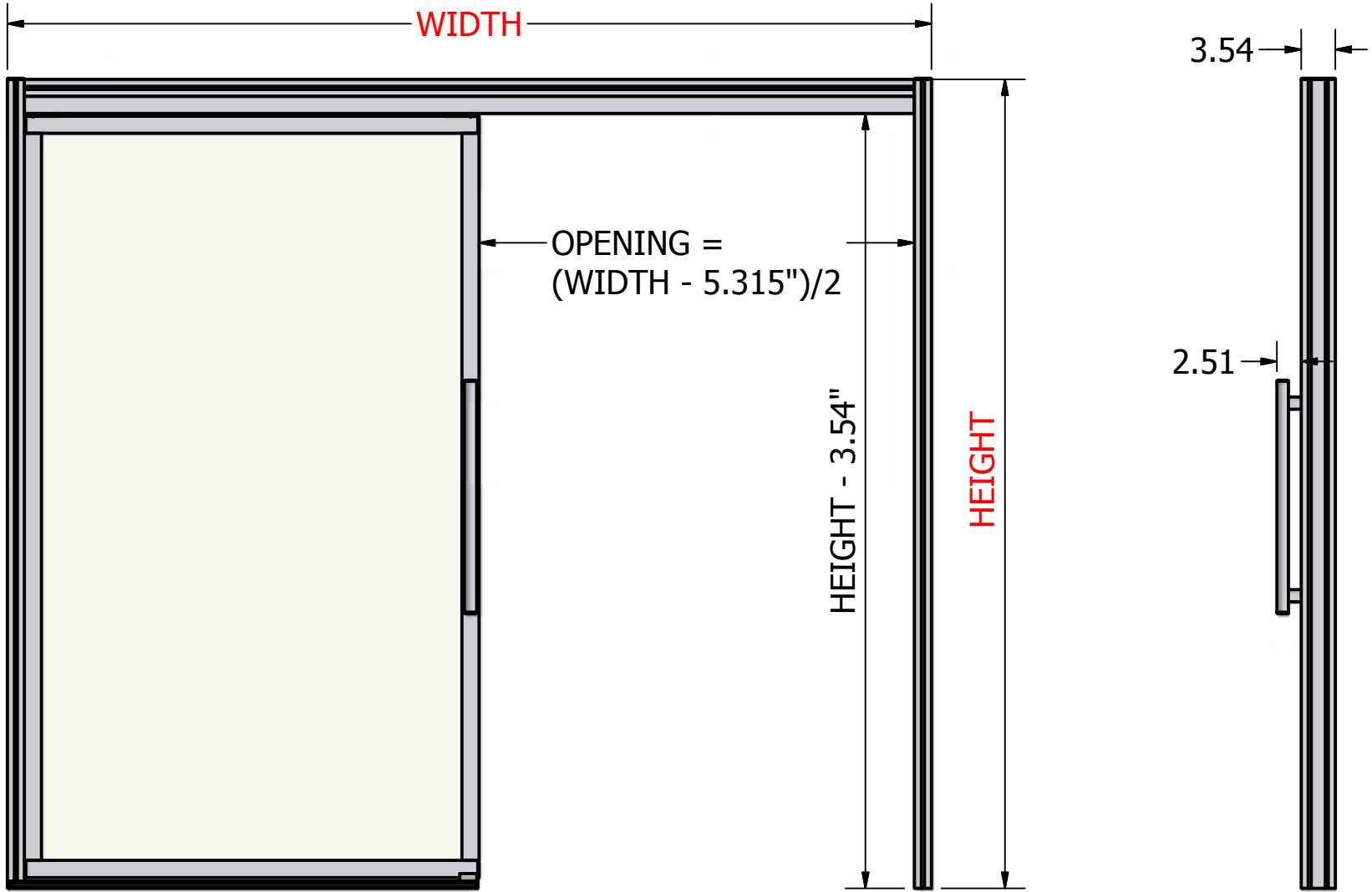

PROJECT SP092112-1		 <small>WWW.MINITECFRAMING.COM VICTOR, NY PH # 585 924-4690 DIRECT 585 398-1240 EXT 104 FX # 585 924-4821 amoles@minitecframing.com</small>	REV		
DRAWN BY ANDY MOLES			DWG NO		
DATE 12/10/2012			SP092112-1		
DRAWN FOR MINITEC'S CUSTOMER		TITLE ADD TITLE		MATERIAL	
<small>TOLERANCES UNLESS OTHERWISE NOTED X +/- .1/32" .XX +/- .015" .XXX +/- .010"</small>		FINISH		SHEET 2 OF 6	

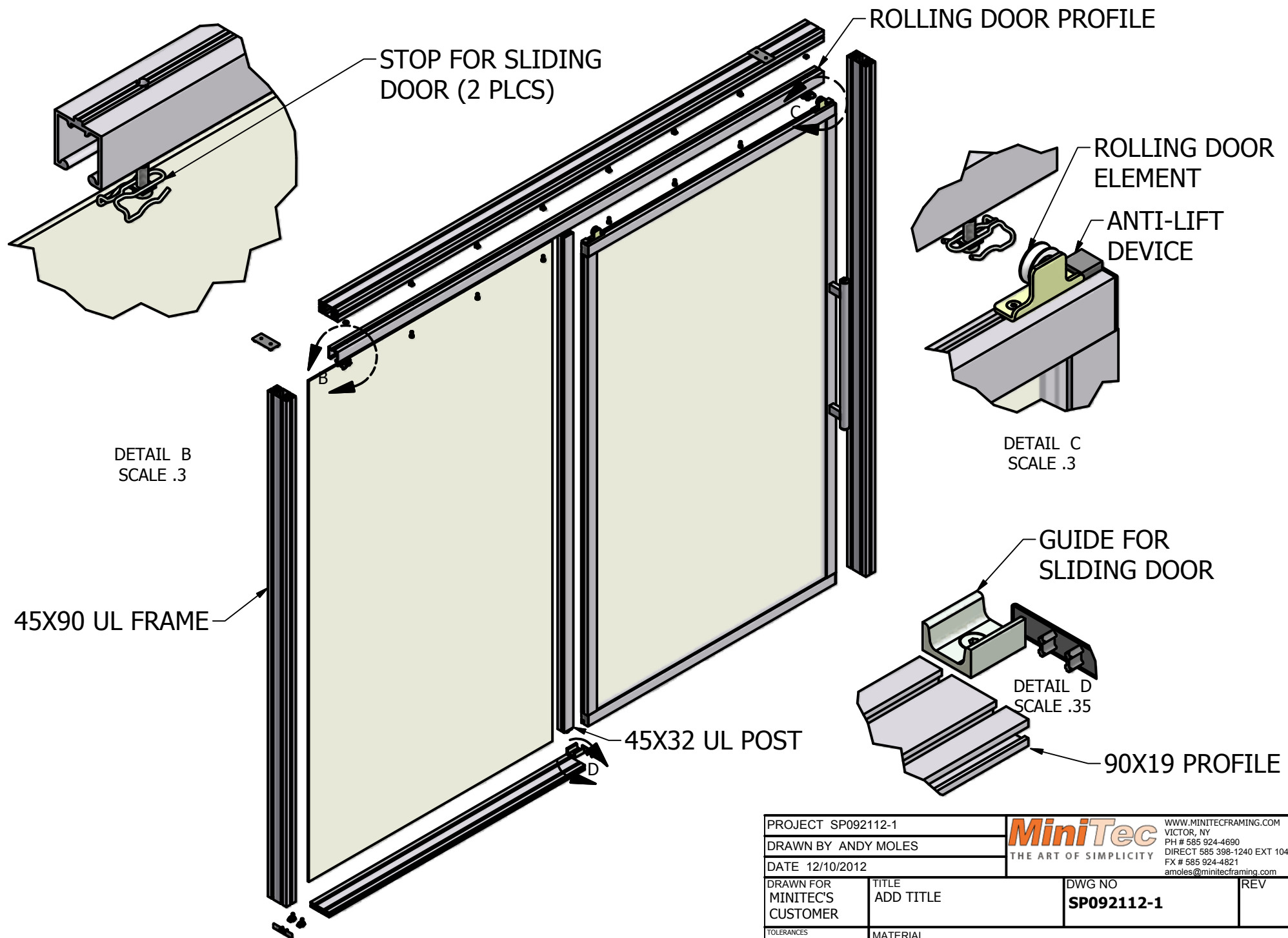

PROJECT SP092112-1		 <small>WWW.MINITECFRAMING.COM VICTOR, NY PH # 585 924-4690 DIRECT 585 398-1240 EXT 104 FX # 585 924-4821 amoles@minitecframing.com</small>	REV
DRAWN BY ANDY MOLES			DWG NO
DATE 12/10/2012			SP092112-1
DRAWN FOR MINITEC'S CUSTOMER	TITLE ADD TITLE	MATERIAL	
TOLERANCES UNLESS OTHERWISE NOTED X +/- .12" .XX +/- .015" .XXX +/- .010"		FINISH	
			SHEET 3 OF 6

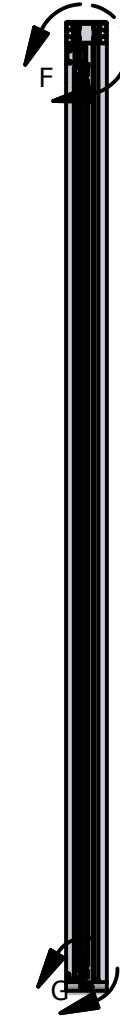
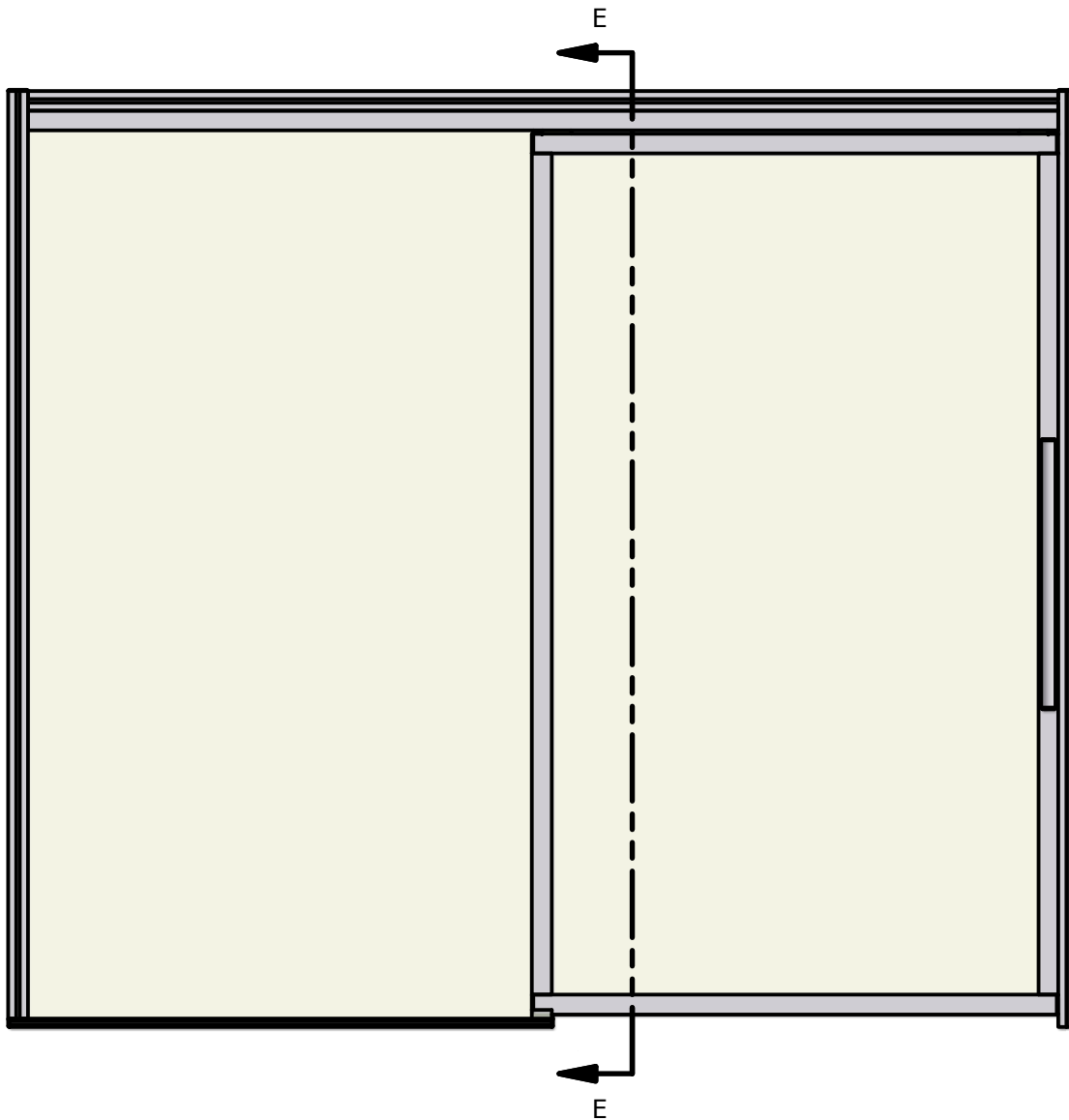

SECTION E-E
SCALE .06

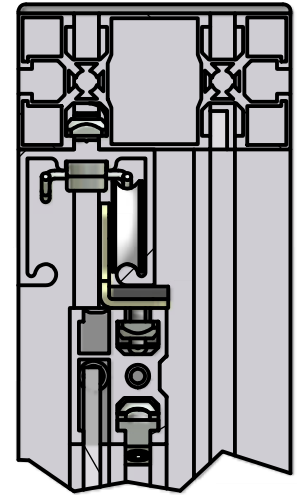

DETAIL F
SCALE .4

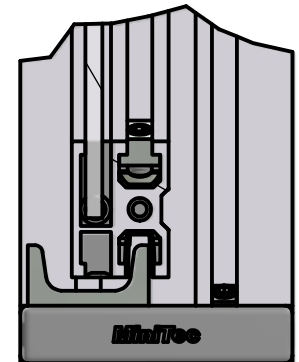

DETAIL G
SCALE .4

PROJECT SP092112-1			WWW.MINITECFRAMING.COM	
DRAWN BY ANDY MOLES			VICTOR, NY	
DATE 12/10/2012			PH # 585 924-4690	
DRAWN FOR MINITEC'S CUSTOMER		DIRECT 585 398-1240 EXT 104		FX # 585 924-4821
TITLE ADD TITLE		DWG NO SP092112-1		REV
TOLERANCES UNLESS OTHERWISE NOTED X +/- .125" .XX +/- .015" .XXX +/- .010"		MATERIAL		SHEET 4 OF 6
FINISH				

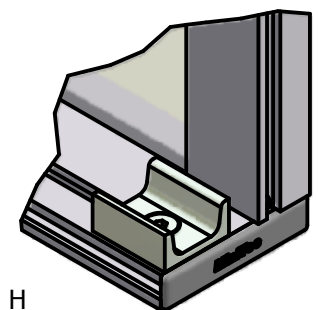
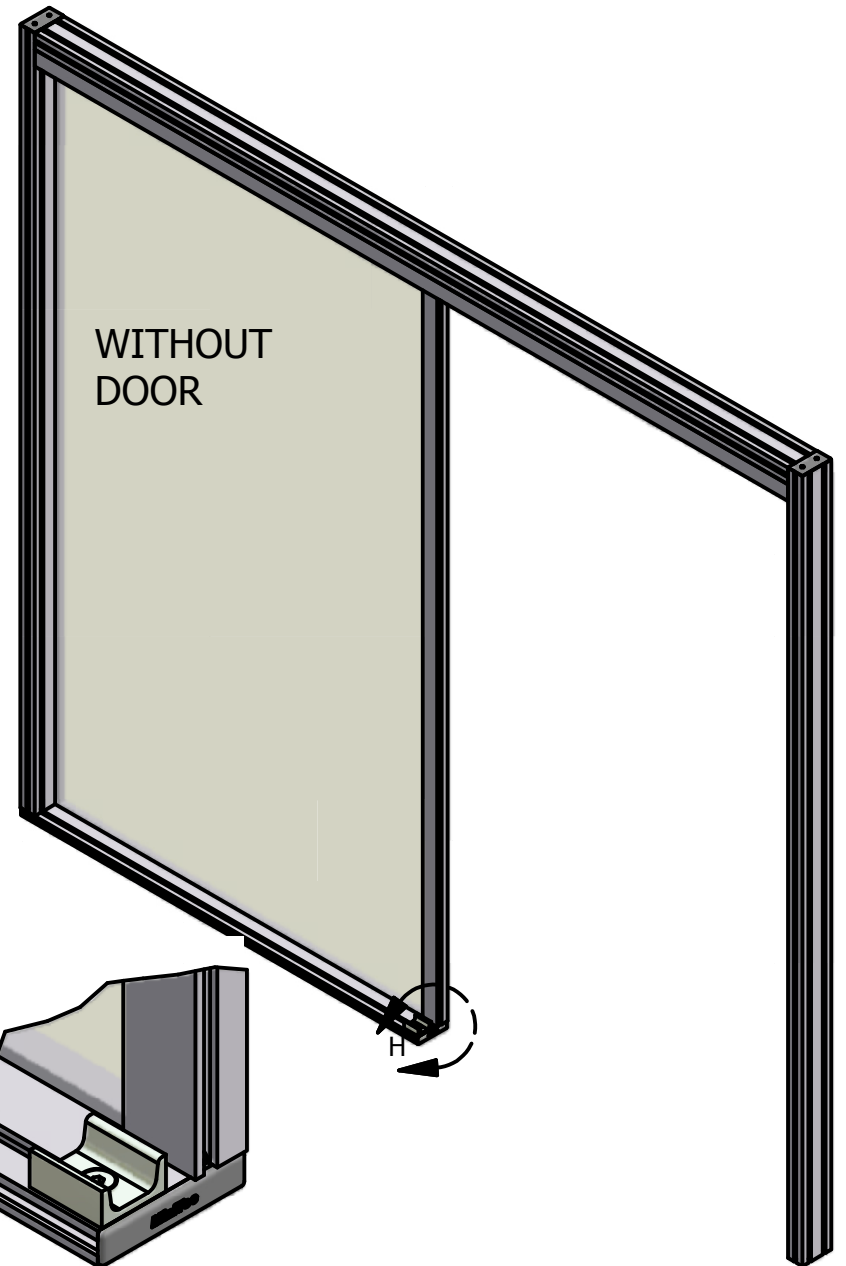
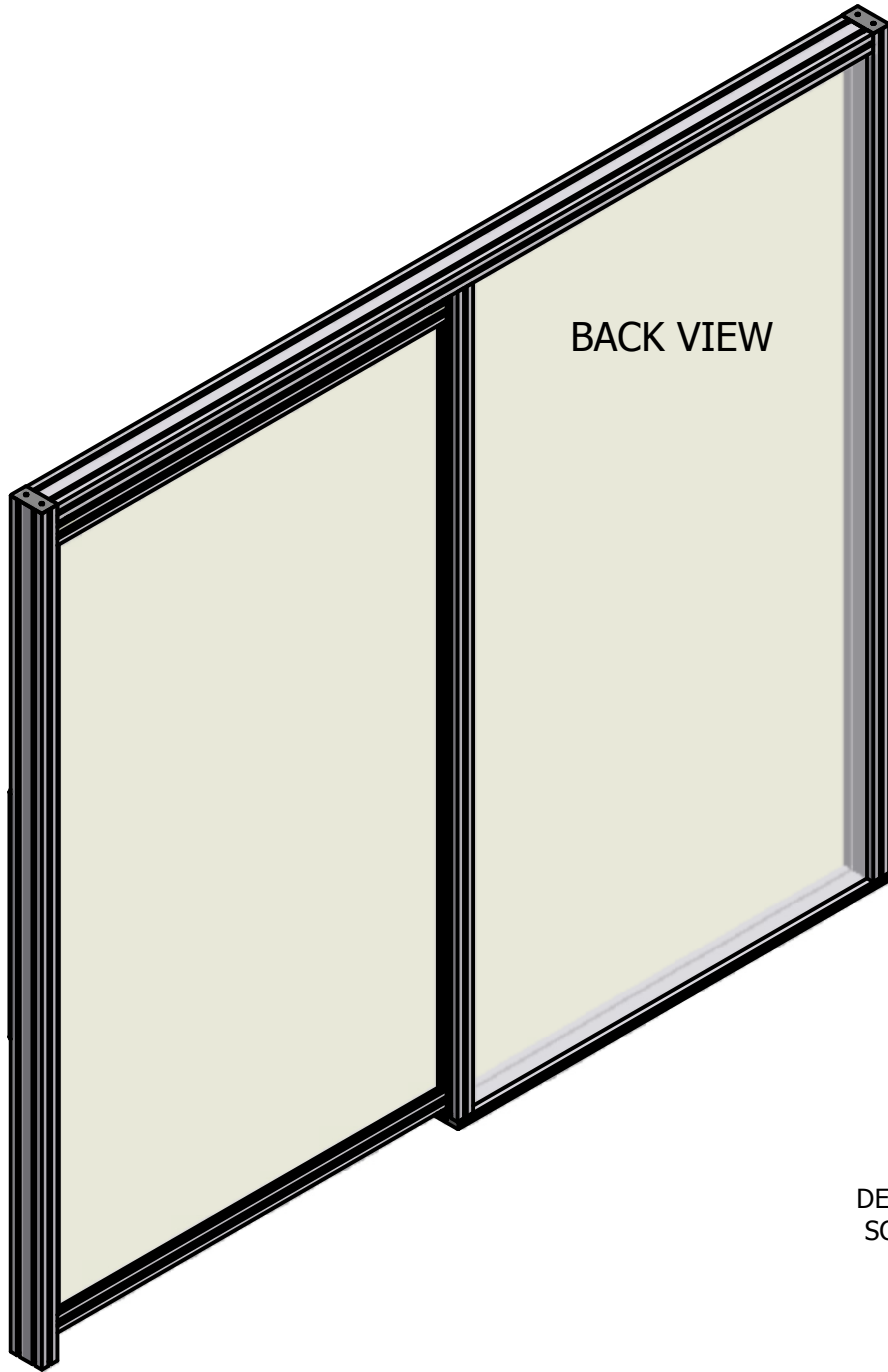

DETAIL H
SCALE .3

PROJECT SP092112-1		 <small>THE ART OF SIMPLICITY</small>	<small>WWW.MINITECFRAMING.COM</small> <small>VICTOR, NY</small> <small>PH # 585 924-4690</small> <small>DIRECT 585 398-1240 EXT 104</small> <small>FX # 585 924-4821</small> <small>amoles@minitecframing.com</small>	
DRAWN BY ANDY MOLES			DWG NO	
DATE 12/10/2012			SP092112-1	
DRAWN FOR MINITEC'S CUSTOMER		TITLE ADD TITLE		REV
<small>TOLERANCES UNLESS OTHERWISE NOTED X +/- .1/32" .XX +/- .015" .XXX +/- .010"</small>		MATERIAL		SHEET 5 OF 6
		FINISH		

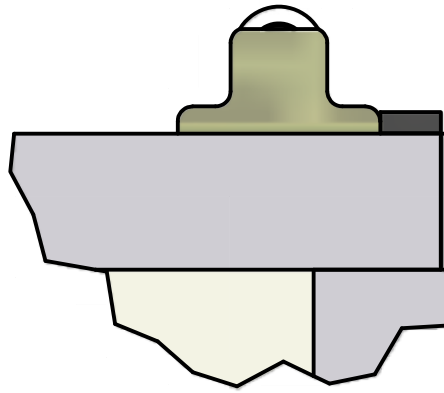
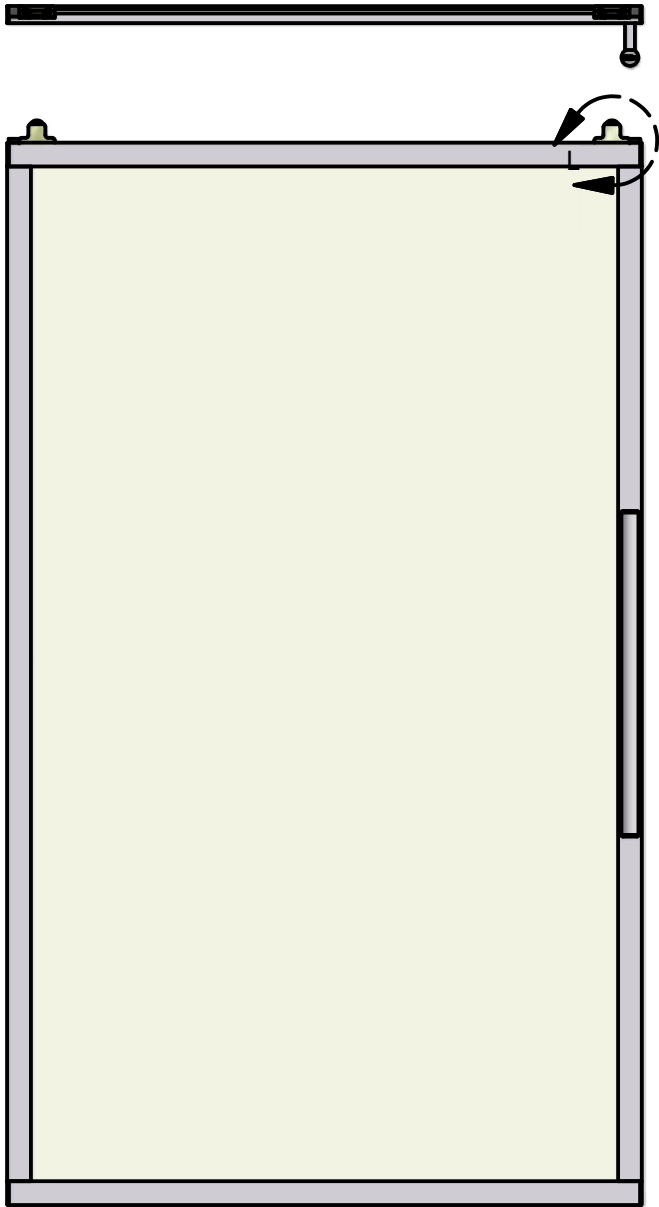

DETAIL L
SCALE .4

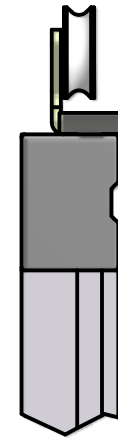
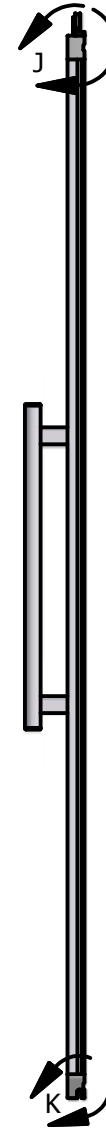

DETAIL J
SCALE .4

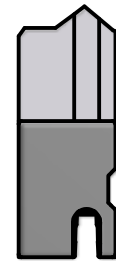

DETAIL K
SCALE .4

PROJECT SP092112-1			WWW.MINITECFRAMING.COM	
DRAWN BY ANDY MOLES			VICTOR, NY	
DATE 12/10/2012			PH # 585 924-4690	
DRAWN FOR MINITEC'S CUSTOMER		DIRECT 585 398-1240 EXT 104		REV
TITLE ADD TITLE		FX # 585 924-4821		
MATERIAL		DWG NO SP061512-1 DOOR		SHEET 6 OF 6
FINISH				
<small>TOLERANCES UNLESS OTHERWISE NOTED X +/- .125" XX +/- .015" XXX +/- .010"</small>				